



1x4 HDMI Splitter with EDID Manager





Safety and Notice

The **AV-GM06E3-S1E 1x4 HDMI Splitter with EDID Manager** has been tested for conformance to safety regulations and requirements, and has been certified for international use. However, like all electronic equipments, the **AV-GM06E3-S1E** should be used with care. Please read and follow the safety instructions to protect yourself from possible injury and to minimize the risk of damage to the unit.

- Follow all instructions and warnings marked on this unit.
- Do not attempt to service this unit yourself, except where explained in this manual.
- Provide proper ventilation and air circulation and do not use near water.
- Keep objects that might damage the device and assure that the placement of this unit is on a stable surface.
- Use only the power adapter and power cords and connection cables designed for this unit.
- Do not use liquid or aerosol cleaners to clean this unit. Always unplug the power to the device before cleaning.



TABLE OF CONTENTS

INTRODUCTION.....	1
FEATURES.....	1
PACKAGE CONTENTS	1
SPECIFICATIONS	2
PANEL DESCRIPTIONS.....	3
HDMI PIN DEFINITION.....	4
HARDWARE INSTALLATION.....	4
CONNECTION DIAGRAM	5
NOTICE	6
WARRANTY	8

INTRODUCTION

The **AV-GM06E3-S1E 1x4 HDMI Splitter with EDID Manager** provides the most robust, cost effective and advanced HDMI splitter solution in the market, by which the high definition video and high quality audio can be transmitted to 4 different locations without losing quality. With both automatic EDID learning and user define EDID features, AV-GM06E3-S1E will effectively avoid HDMI compatibility issues and offer the best HDMI support for HDMI splitters!

With built-in USB firmware update mechanism, the compatibility among countless HDMI sources and receivers can be further guaranteed. With 12-bit deep color video and high definition audio support, AV-GM06E3-S1E is suitable for high quality A/V broadcasting, digital signage and education applications!

FEATURES

- Support HDMI Deep Color & 3D / DVI 1.0 compliant
- HDCP 1.2 compliant
- Wide Frequency Range: 25MHz~225MHz
- Video bandwidth: 6.75Gbps
- Supports conversion of HDMI signaling to DVI
- Resolution up to 1080p or WUXGA [1920x1200@60]
- Automatic EDID learning
- 4 DIP switch controllable EDID sets
- Supports x.v.YCC, x.v.Color & Deep Color
- Supports CEC bypassing communication channel
- USB firmware update for expanding compatibility
- Supports Dolby Digital, DTS-HD and Dolby TrueHD audio formats
- Wall-mount housing design for easy installation



Automatic EDID learning will detect all the connected HDMI equipped monitors and analyze all the content of EDID. The EDID with minimal resolution support will be the reference EDID for incoming HDMI source players.

PACKAGE CONTENTS

- 1x AV-GM06E3-S1E
- 1x DC 5V 4A in-line with C7 power cord
- 1x User Manual

SPECIFICATIONS

Model Name	AV-GM06E3-S1E	
Technical		
Role of usage	1x4 Distribution Amplifier (Splitter)	
HDMI compliance	HDMI Deep Color & 3D	
HDCP compliance	Yes	
Video bandwidth	Single-link 225MHz [6.75Gbps]	
Video support	Up to WUXGA [1920x1200@60Hz] & UXGA [1600x1200@60Hz]	
Audio support	DTS-HD Master Audio, Dolby TrueHD Dolby Digital, DTS, DVD-Audio, LPCM, SACD, MPCM	
Input TMDs signal	1.2 Volts [peak-to-peak]	
Input DDC signal	5 Volts [peak-to-peak, TTL]	
ESD protection	[1] Human body model — ±19kV [air-gap discharge] & ±12kV [contact discharge] [2] Core chipset — ±8kV	
PCB stack-up	4-layer board [impedance control — differential 100Ω; single 50Ω]	
Input	1x HDMI	
Output	4x HDMI	
HDMI connector	Type A [19-pin female]	
Switch number	4	
Mechanical		
Housing	Metal enclosure	
Dimensions [L x W x H]	Model	195 x 109 x 27mm [7.7" x 4.3" x 1"]
	Package	330 x 200 x 95mm [1'1" x 7.9" x 3.7"]
	Carton	495 x 440 x 380mm [1'7" x 1'5" x 1'3"]
Weight	Model	593g [1.3 lbs]
	Package	980g [2.2 lbs]
Fixedness	Wall-mounting case with screws	
Power supply	5V 4A DC	
Power consumption	4 Watts [max]	
Operation	0~40°C [32~104°F]	

temperature	
Storage temperature	-20~60°C [-4~140°F]
Relative humidity	20~90% RH [no condensation]

PANEL DESCRIPTIONS

Rear Panel

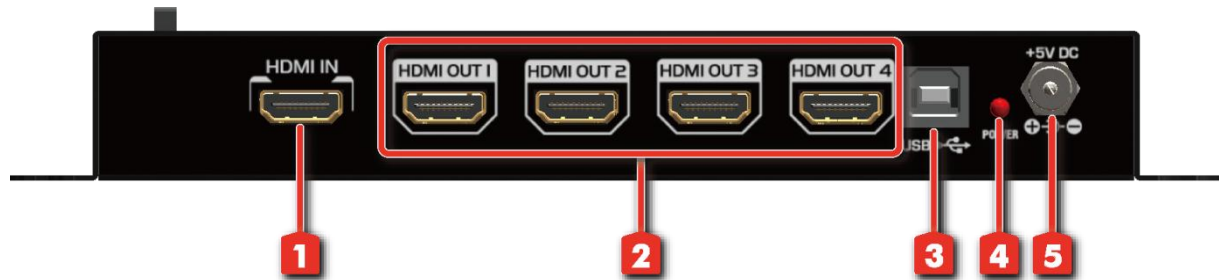

1. **HDMI IN:** HDMI input source
2. **HDMI OUT 1-4:** distributed HDMI outputs
3. **USB:** for firmware update use only
4. **POWER:** Red light means power is on
5. **+5V DC:** connect to 5V 2A interlocking power supply unit

Top Panel

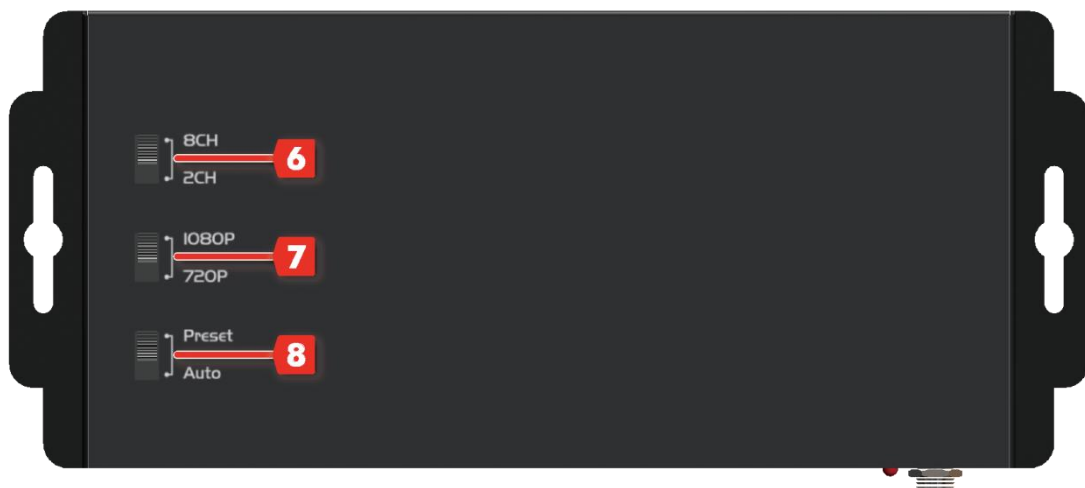

6. **SW1:** 8CH / 2CH
7. **SW2:** 1080P / 720P
8. **SW3:** Present / Auto

HDMI PIN DEFINITION

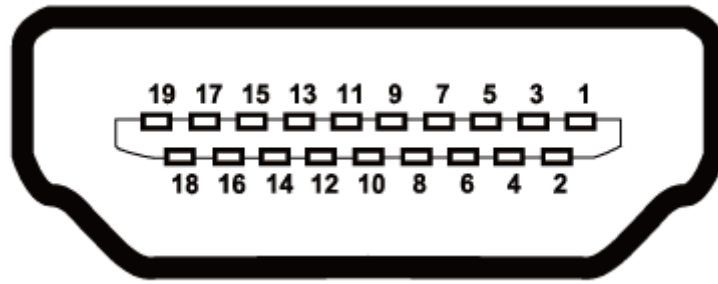

Type A (Receptacle) HDMI

Pin 1	TMDS Data2+	Pin 8	TMDS Data0 Shield	Pin 14	Reserved (N.C. on device)
Pin 2	TMDS Data2 Shield	Pin 9	TMDS Data0-	Pin 15	SCL
Pin 3	TMDS Data2-	Pin 10	TMDS Clock+	Pin 16	SDA
Pin 4	TMDS Data1+	Pin 11	TMDS Clock Shield	Pin 17	DDC/CEC Ground
Pin 5	TMDS Data1 Shield	Pin 12	TMDS Clock-	Pin 18	+5V Power
Pin 6	TMDS Data1-	Pin 13	NC	Pin 19	Hot Plug Detect
Pin 7	TMDS Data0+				

HARDWARE INSTALLATION

Broadcasts HDMI signal to 4 HDMI displays!

1. Switch off all devices, including monitors.
2. Connect to the receivers.
3. Connect an HDMI source (such as a Blu-ray Disc player) to the HDMI In.
4. Plug in 5V DC power supply unit.
5. Power on the HDMI monitors.
6. Power on the HDMI source.

CONNECTION DIAGRAM

→ HDMI

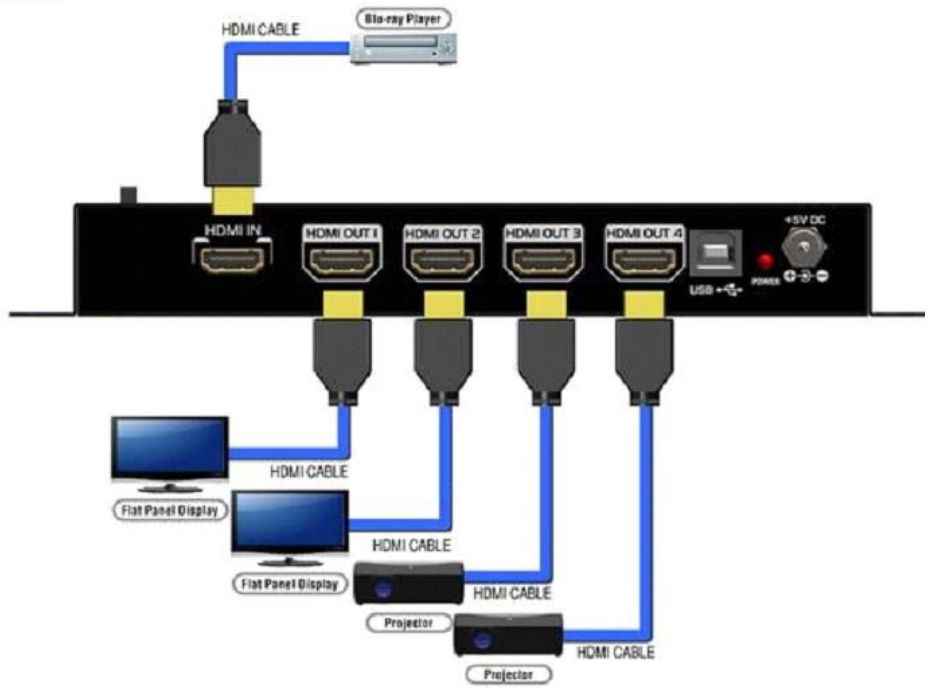

NOTICE

1. While connecting a new monitor to the splitter, experiencing a short period of time no display may be expected. Automatic EDID learning will analyze the newly connected monitor to see if the EDID for the HDMI input is necessary to update!
2. For long range high definition HDMI transmission applications, please adopt CAT5/6 cable based HDMI extenders.
3. Users need to install USB driver before applying firmware update process! Please search for "PL2303" by Google and therefore use the most updated driver for your OS!



4. For firmware update through USB and since there are 2 independent microcontrollers in AV-GM06E3-S1E, users MUST follow different steps to complete the firmware update! For some cases, users may need to update both controllers, but in most of the cases, only one of them may need to be upgraded. For normal uses, please do not connect USB cable to the USB port. Please also disconnect all the HDMI source and displays to avoid any other possibilities to cause technical issues. A 2-pin DIP switch is used for firmware update, and users can access this switch from the bottom of the unit. The following table demonstrates the functionality that users can change through different pin combinations.

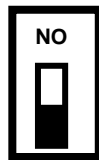

Pin ON (↑):

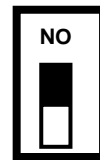

Pin OFF (↓):

Combination #	Pin # 1 & 2	Functionality when USB is connected
1	ON (↑)ON (↑)	MIC#1 enters updating mode
2	ON (↑)OFF (↓)	MIC#1 enters updating mode
3	OFF (↓)ON (↑)	MIC#2 enters updating mode
4	OFF (↓)OFF (↓)	MIC#2 prepares to enter updating

		mode
--	--	------

5. For updating the first microcontroller, please set the pin 1 & 2 of the bottom DIP as the positions shown in the above table. Then, turn off the power, plug USB cable connected to your PC, and then power up the module! In this setup, the power LED indicator will NOT blink, and this is normal! Execute the attached or download EPFlash.exe, and the following window will pop up. Click on "OpenFile" button to direct to the new firmware HEX file, and keep PORT at USB 0! Meantime, keep "Program With Verification" selected, and then click on "START" button on the bottom of the window! Wait for seconds until the update process is completed! After firmware update is successfully accomplished, please unplug USB cable and power off the splitter!

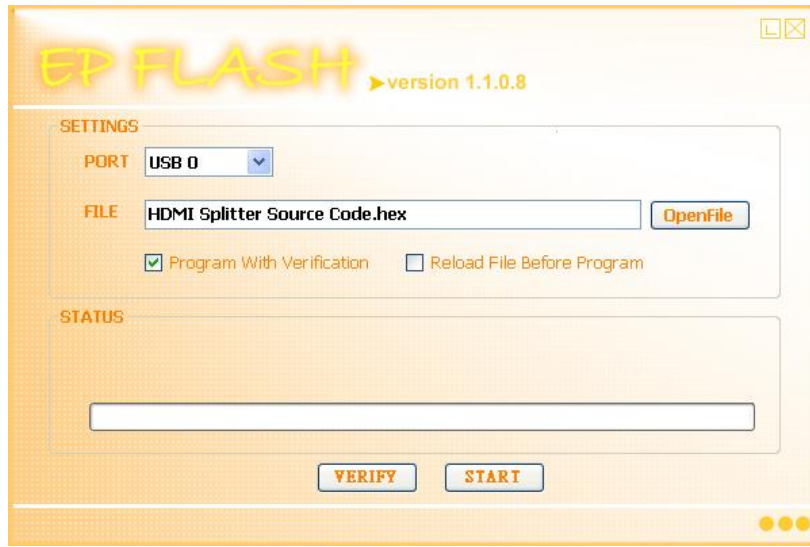

6. For updating the second microcontroller if necessary, please execute the attached firmware program as below first! After the "Firmware Writer" is executed, please set the pin 1& 2 of the bottom DIP as Combination 4 in the above table to prepare to enter updating mode first. Wait for 1 ~ 2 seconds, please set the DIP switch as Combination3. The "Firmware Writer" will load automatically the latest firmware into the second micro-controller!

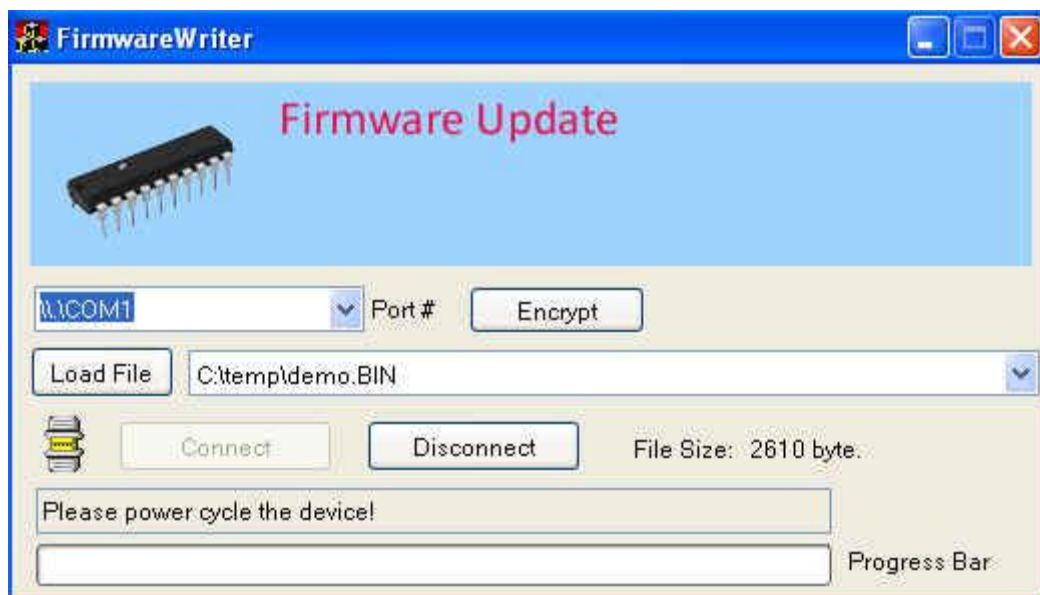

WARRANTY

The SELLER warrants the **AV-GM06E3-S1E 1x4 HDMI Splitter with EDID Manager** free from defects in the material and workmanship for 3 years from the date of purchase from the SELLER or an authorized dealer. Should this product fail to be in good working order within 3 years warranty period, The SELLER, at its option, repair or replace the unit, provided that the unit has not been subjected to accident, disaster, abuse or any unauthorized modifications including static discharge and power surge. This warranty is offered by the SELLER for its BUYER with direct transaction only. This warranty is void if the warranty seal on the metal housing is broken.

Unit that fails under conditions other than those covered will be repaired at the current price of parts and labor in effect at the time of repair. Such repairs are warranted for 90 days from the day of reshipment to the BUYER. If the unit is delivered by mail, customers agree to insure the unit or assume the risk of loss or damage in transit. Under no circumstances will a unit be accepted without a return authorization number.

The warranty is in lieu of all other warranties expressed or implied, including without limitations, any other implied warranty or fitness or merchantability for any particular purpose, all of which are expressly disclaimed.

Proof of sale may be required in order to claim warranty. Customers outside Taiwan are responsible for shipping charges to and from the SELLER. Cables and power adapters are limited to a 30 day warranty and must be free from any markings, scratches, and neatly coiled.

The content of this manual has been carefully checked and is believed to be accurate. However, The SELLER assumes no responsibility for any inaccuracies that may be contained in this manual. The SELLER will NOT be liable for direct, indirect, incidental, special, or consequential damages resulting from any defect or omission in this manual, even if advised of the possibility of such damages. Also, the technical information contained herein regarding the **AV-GM06E3-S1E** features and specifications is subject to change without further notice.

Support

For more info or tech support

<http://www.siig.com/support>